



## Timer with Instantaneous Relay

- ON-Delay version with instantaneous relay
- Selectable ON-Delay/Interval Timing Mode version
- Output Contacts rated 10A 120/240 VAC and 30 VDC
- Six Timing Ranges in a single unit
- Timing Ranges:
  - 1 and 10 SEC, MIN, and hours
  - 5 and 50 SEC, MIN, and hours
- Universal Power Supply: 24-240 VAC and 24 VDC
- 48mm<sup>2</sup> DIN Standard housing
- Large and *easy to read* dial shows decimal points
- Round (octal) socket mount or mount in panel cutout
- *Watertight* when panel mounted
- Range and Mode select are *tamper proof* when panel mounted
- Unique flashing cycle progress indication

**Instantaneous & Delayed:** A version of the 405A is available with one set of SPDT instantaneous contacts and one set of SPDT delayed contacts. The instantaneous contacts transfer as soon as the timer is powered. The delayed contacts transfer at time out. This contact arrangement can be used to replace many conventional timers.

**On Delay/Interval Timing Mode Version:** A version of the 405A is available with selectable ON-delay or Interval timing modes. This version has a set of DPDT output contacts. When in the ON-delay mode, the contacts transfer at time out. When in the Interval mode, the contacts transfer when power is applied and release at time out.

**Universal Power:** All 405A timers can be powered using 24-240 VAC or 24 VDC power, greatly simplifying ordering and inventory management of replacement units.

**1/16 DIN Housing:** The 48mm<sup>2</sup> (1/16 DIN) housing is compact and is watertight when panel mounted. The 405A is mounted in an 8-pin round (octal) socket. With an optional mounting clip, the 405A can be panel mounted.

The Dial on the 405A is extra large and is easy to read. When fractional ranges are selected, decimal points are clearly indicated.

The Mode select and Range select switches are located on the side of the unit, so that when panel mounted, these switches are not accessible to the operator. This tamper proof feature prevents unauthorized or hazardous changes to the timing mode and range from being made.

**Cycle Progress Indication:** The 405A LED indicator provides a unique and effective method of cycle progress indication. Off before timing, the LED blinks at an ever increasing rate as the cycle progresses: once every 3-1/2 seconds during the first 10% of the cycle, twice during the second 10%, and so on. At time out, the LED pulses at a high rate. (In the 1, 5, 10 and 50 second ranges, the LED is OFF before timing, steady ON during timing, and pulsing ON after time-out).

### OPERATIONS

Timing begins when the start switch is closed. This starts an oscillator which runs at a frequency determined by the time setting. A fixed number of counts from the oscillator determines the end of the timing cycle. The time required to accomplish this depends upon the oscillator frequency. During timing, an LED located on the dial face blinks. For the first 10% of the cycle, LED repeatedly blinks once followed by a pause. For the second 10%, it blinks twice and so on indicating the cycle progress. The LED flashes rapidly and continuously after time out.

#### MODEL...F1X

The instantaneous contacts (3-1-4) transfer immediately after the start switch is closed. The delayed contacts (6-8-5) transfer after the timing cycle indicated on the front dial setting. Both contacts remain transferred until the unit is reset.

#### MODEL...F2X

**ON DELAY MODE:** At time out, the DPDT relay transfers its contacts. These contacts remain transferred until the start switch is opened or power is removed by some other means. The 405A then resets and is ready for another cycle.

**INTERVAL MODE:** When the start switch is closed, the DPDT relay transfers its contacts. The contacts remain transferred until time out. The timer will not start again until the start switch is opened or power is removed by some other means. The 405A then resets and is ready for another cycle.

SPECIFICATIONS	
MODELS	405A100F1X ON-Delay w/instantaneous & delayed relays (1 or 10 SEC/MIN/HRS)
	405A500F1X ON-Delay w/instantaneous & delayed relays (5 or 50 SEC/MIN/HRS)
	405A100F2X ON-Delay/Interval with (1) DPDT relay (1 or 10 SEC/MIN/HRS)
	405A500F2X ON-Delay/Interval with (1) DPDT relay (5 or 50 SEC/MIN/HRS)
	Both models available in 6 ranges from 1 SEC to 10 HRS or 5 SEC to 50 HRS
CONTACT RATING	Rated 10 AMPS resistive at 30 VDC or 250 VAC (or less)
	1/8 HP @120 VAC
	1/4 HP @ 240 VAC
	240 VA @ 240 VAC
	LIFE: 10 million operation with no load 100,000 operations with: 10 AMPS at 30 VDC (or less) or 10 AMPS at 250 VAC (or less)
CONTACT MATERIAL	Silver Cadmium Oxide
TEMPERATURE RATING	0 to 122°F (-18°C to 50°C)
NOISE IMMUNITY	Showering ARC per NEMA ICS 2-230. In addition, the 405A will withstand a voltage surge of 4500 volts for 50 μSEC without damage.
MOUNTING	Plug-in octal base; mounts in any position with retaining clip.
	Options: Surface mounting socket DIN rail mounting socket Panel-mounting adapter kit Plug-on socket kit
POWER REQUIREMENTS	Universal power supply - reverse polarity protected Unit will accept power from 24 to 240 VAC, 50 or 60 Hz, (+10%, - 20%) 24 VDC (+20%, - 20%)
	AC Inrush - 1.5 Amps Power required - 1.2 watts
	DC Maximum ripple @100Hz - 5% Current required - 50mA Power required - 1.2 watts "F" option - Peak inrush current = 2 AMPS @ 24 VDC "N" option - Peak inrush current = 150 mA @ 24 VDC
REPEAT ACCURACY	Varies as a function of temperature. Any voltage (constant temperature): +/-0.5%*
	Any voltage (32° F to 140° F): +/-1.5%*
	Any voltage (0° F to 140° F): +/-2.0%*
	*Variation from average actual time.
MINIMUM SETTING	2% of range, with the exception of 50 mSEC on the 1 second range
SETTING ACCURACY	+/-5% of range
RESET	a 0 to 20 mSEC power interruption: guaranteed no reset.
	b 20 to 65 mSEC; it may reset (40 mSEC typical reset).
	c Over 65 mSEC guaranteed to reset.
	The TDR will reset properly and not start timing when subjected to an open start switch leakage of 1.5 mA or less. (Prox switch and Triac drive applications)
WEIGHT	5 oz. (140g)

MODEL NUMBER >>>>>>	405A			
Range				
Six dial-selected ranges (1 or 10 SEC/MIN/HRS)	100			
Six dial-selected ranges (5 or 50 SEC/MIN/HRS)	500			
Voltage & Frequency				
12 VDC	E			
24 to 240 VAC (50/60 Hz) and 24 VDC	F			
24 VDC (low inrush current for short-circuit protected sensors)	N			
Arrangement				
8-pin ON-Delay (with instantaneous contacts) Timing Mode	1			
8-pin ON-Delay, Interval Timing Modes	2			
Features				
Standard	X			
Special	K			
Accessories				
8-Pin surface/DIN rail socket	0000-825-85-00			
Hold down for above socket	0407-025-13-00			
Panel mounting bracket	0405-320-02-00			
Plug-in socket kit (8-pin)	0319-261-45-00			
8-Pin panel socket w/rear facing terminals	600-3-0011			

WIRING

WIRING

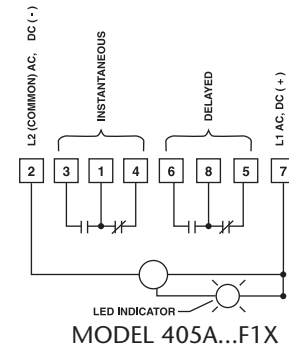

TERMINAL WIRING

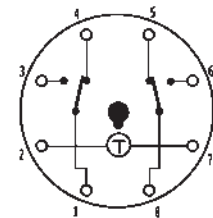

WIRING

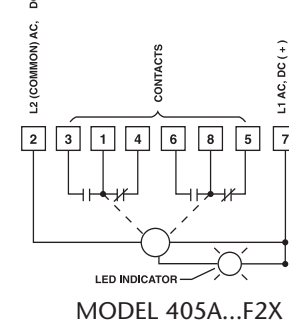

DIMENSIONS (INCHES/MILLIMETERS)

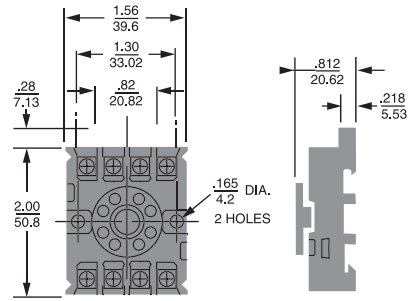
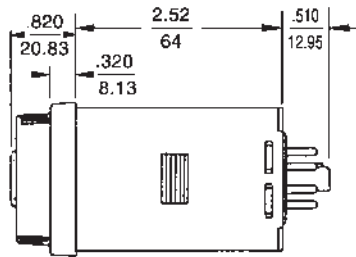
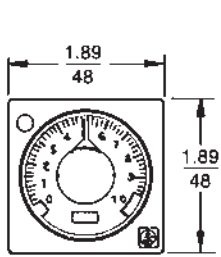

8 PIN OPTIONAL OCTAL SOCKET NO. 00008258500

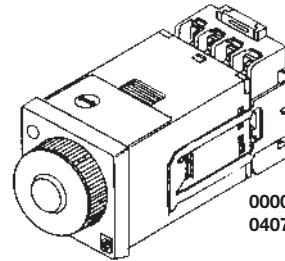
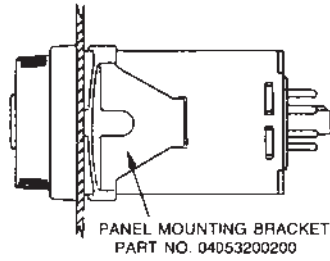
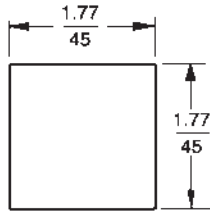

0008258500 SOCKET WITH 04070251300 HOLD DOWN

TYPICAL CIRCUITS

405A...F1X

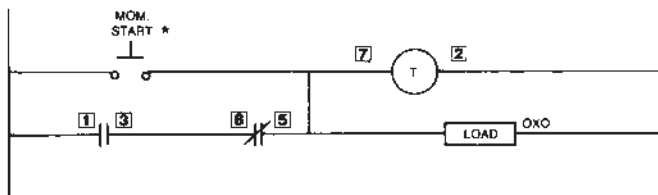

\*Minimum Momentary Switch Closure Time — 50 mSEC

405A...F2X

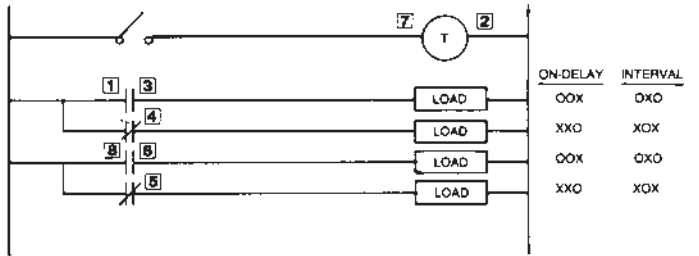

\* For Interval Operation With A Momentary Start Switch, Jumper 7 & 3

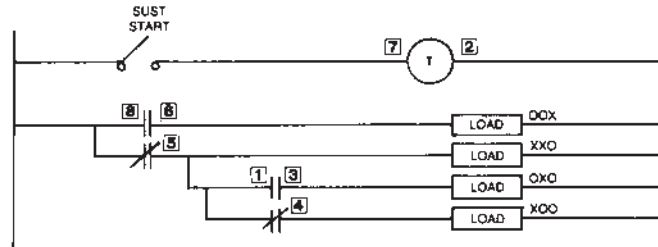

For Repeat Cycle Pulse Operation In On-Delay Mode.

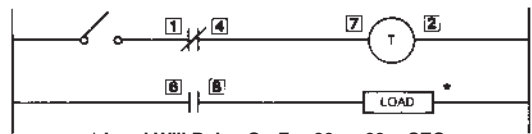

\* Load Will Pulse On For 30 — 60 mSEC

