

# Contents

	Applications		Page 4
	OA/OW 5669	1 NO/1 NC, 2 CO, 2 NO, 2 NC	Page 6
	OA 5611	2 NO/2 NC, 3 NO/1 NC	Page 10
	OA 5612	2 NO/4 NC, 3 NO/3 NC, 4 NO/2 NC	Page 12
	OA 5601	2 NO/2 NC, 3 NO/1 NC	Page 14
	OA 5602	2 NO/4 NC, 3 NO/3 NC, 4 NO/2 NC	Page 16
	OA 5603	7 NO/1 NC, 6 NO/2 NC, 5 NO/3 NC, 4 NO/4 NC, 3 NO/5 NC, 2 NO/6 NC	Page 18
	Safety Relay Modules	Bussed Channel Isolated Channel	Page 20
	Terminology		Page 26
	Accessories		Page 29
	Terms & Conditions		Page 30

# Applications

Safety relays with forced-guided contacts are the core components for safety devices and are indispensable when designing safety circuits. Safety devices are designed to protect man and machine as demanded in OSHA CFR 1910 Regulations "General Requirements for All Machinery", and which is a mandatory requirement of the European Machinery Directive EMD 89/392 EEC.

DOLD safety relays are approved for use in safety applications to IEC 60204, EN 60204, DIN/VDE 0113, such as:



## Typical Applications

- Emergency stop modules
- DIN Rail safety modules
- Safety door controls
- Two-hand operating devices
- Pressure mat controls
- Light barriers and curtains
- Speed controls
- Monitoring devices

## Equipment controls systems for:

- Elevators and escalators
- Cranes
- Door and gate drive systems
- Printing and textile machinery
- Robots
- Stamping machines
- Medical equipment
- Cutting machines
- Rail transportation systems
- Signaling systems

## WARNING

**Improper** use and installation of safety relays - modules into safety related circuitry without complying with the applicable regulations can cause serious injury to the operator.

**Due** to the wide range of potential users and customers' interpretation of the standards covering the applications of the safety relays described in this brochure, it is impossible for DOLD personnel or sales agents to be familiar with all safety and health standards and requirements that may apply to any specific application.

**It** is the responsibility of the user to determine the suitability of a safety relay for the intended application and to determine that the safety relay chosen and its installation will comply with all applicable safety and health regulations and codes.



## DOLD SAFETY MODULES

## PRODUCT BULLETIN

Safety Modules are a mandatory requirement of European Machinery Directive EMD 89/392 EEC. This requirement is for risk reduction purposes in order to protect personnel and machinery. Built for the International Market and Global Machine Design, all fail-to-safe modules are designed with Dual Logic Circuits, each of which provides a safety function carried out by safety relays with forced guided contacts.



### Safety Module Selector Guide

	Application	Features
<b>BN 5983</b> 	Emergency Stop Module Safety Gate Monitor	<ul style="list-style-type: none"> <li>Coil Voltage: 24, 48, 110, 127, 230, 240V AC, or 24V DC</li> <li>Max. Switching Current: 10A</li> <li>Max. Switching Voltage: 415V AC, 250V DC</li> <li>Dimension: 100mm</li> <li>3 NO output contacts</li> <li>LED indicator for channels 1 and 2</li> <li>Quick disconnect terminal strips</li> <li>Front mounted fuse (optional)</li> </ul>
<b>BD 5987</b> 	Emergency Stop Module Safety Gate Monitor	<ul style="list-style-type: none"> <li>Coil Voltage: 24, 48, 110, 127, 230, 240V AC, or 24V DC</li> <li>Max. Switching Current: 10A</li> <li>Max. Switching Voltage: 250V AC, 250V DC</li> <li>Dimension: 45mm</li> <li>2 NO output contacts</li> <li>LED indicator for channel 1, channel 2, and line voltage</li> <li>Internal overvoltage protection with auto-reset</li> <li>Line fault detection at ON pushbutton</li> <li>Cross fault detection (optional)</li> </ul>
<b>BO 5988</b> 	Emergency Stop Module Safety Gate Monitor	<ul style="list-style-type: none"> <li>Coil Voltage: DC 24V+ AC 48/110/230 or 240V, DC 24V</li> <li>Max. Switching Current: 10A</li> <li>Max. Switching Voltage: 250V AC, 250V DC</li> <li>Dimension: 100mm</li> <li>6 NO output contacts</li> <li>LED indicator for channel 1, channel 2 and line voltage</li> <li>Internal overvoltage protection with auto-reset</li> <li>Quick disconnect terminal strips</li> <li>Line fault detection at ON pushbutton</li> <li>Cross fault detection (optional)</li> <li>Time delay optional</li> </ul>
<b>BD 5935</b> 	Emergency Stop Module Safety Gate Monitor	<ul style="list-style-type: none"> <li>Coil Voltage: 24, 48, 110, 127, 230, 240V AC, or 24V DC</li> <li>Max. Switching Current: 10A</li> <li>Max. Switching Voltage: 250V AC, 250V DC</li> <li>Dimension: 45mm</li> <li>3 NO output contacts</li> <li>LED indicator for channel 1, channel 2 and line voltage</li> <li>Internal overvoltage protection with auto-reset</li> <li>Quick disconnect terminal strips</li> <li>Line fault detection at ON pushbutton</li> <li>Cross fault and auto-on selection switch located behind front panel</li> </ul>
<b>BD 5985N</b> 	Safety Gate Monitor	<ul style="list-style-type: none"> <li>Coil Voltage: 24, 42, 110, 230, 240V AC, 24V DC</li> <li>Max. Switching Current: 10A</li> <li>Max. Switching Voltage: 250V AC, 250V DC</li> <li>Dimension: 45mm</li> <li>2 NO output contacts</li> <li>Internal overvoltage protection with auto-reset</li> <li>Gate closing time 3 s</li> </ul>
<b>BD 5980N</b> 	2-Hand Safety Module	<ul style="list-style-type: none"> <li>Coil Voltage: 24, 42, 110, 230, 240V AC, 24V DC, 24V DC+ AC</li> <li>Max. Switching Current: 10A</li> <li>Max. Switching Voltage: 250V AC, 250V DC</li> <li>Dimension: 45mm</li> <li>2 NO output contacts</li> <li>Internal overvoltage protection with auto-reset</li> <li>Simultaneous input closing demand of 500 ms</li> </ul>
<b>BN 3081</b> 	Extension Module	<ul style="list-style-type: none"> <li>Coil Voltage: 110, 230V AC, UC 24V</li> <li>Max. Switching Current: 10A</li> <li>Max. Switching Voltage: 415V AC, 250V DC</li> <li>Dimension: 100mm</li> <li>7 NO output contacts</li> <li>LED indicator for channels 1 and 2</li> <li>Quick disconnect terminal strips</li> </ul>

Please call us for other DOLD products

Time Control Relays • Monitoring Relays • Interface Relays • Control Relays



# Safety Relay

## OA/OW 5669

### Features

- 2 output contacts
- International approvals: TÜV, SA, CSA, UL, cUL, SUVA
- Quality control check for each safety relay
- Forced-guided contacts, all gold flash plated
- Contact Gap > 0.5 mm throughout life of relay
- Various contact materials, mixed contact material optional
- High coil voltage range
- High breakdown Voltage: contact/coil > 4 KV
- High Creeping Distance: contact/coil > 8 mm
- Protection Rating  
OA Version: IP 40  
OW Version: IP 67 washable
- Custom design available,  
-coil voltage                      -coil resistance,  
-contact pressure                -operate/release time
- \* Special version available for 85°C ambient temperature

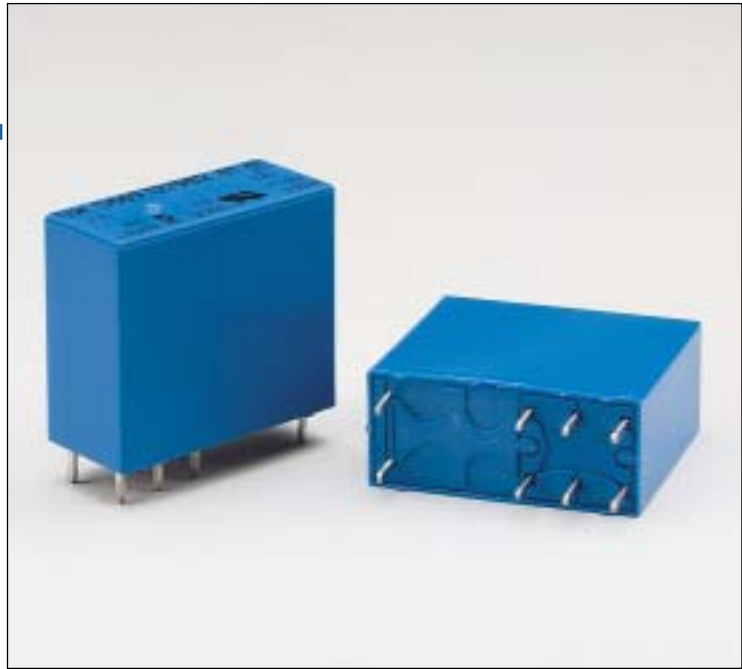

GERMANY



SWEDEN



USA/CANADA



CANADA



SWITZERLAND

## Technical Data

- **Nominal Coil Voltage** .....5, 6, 12, 20, 24, 48, 60, 110, DC
- **Coil Power Dissipation** .....0.7 W
- **Max. Switching Voltage** .....110V DC, 250V AC
- **Max. Switching Current**.....8 A (2 x 5A simultaneous)
- **Max. Switching Power — DC**.....200W (2 x 160W simultaneous)
- **Max. Switching Power — AC**.....2000VA (2 x 1250VA simultaneous)
- **Contact Switching Rate** .....10 operations per second
- **Relay Operate Time** .....15 ms
- **Relay Release Time** .....12 ms
- **Operation Vibration** .....0.35 mm Ampl. max @ 10...55Hz, 5g max
- **Contact Arrangements**.....1NO/1NC, 2CO, 2NO, 2NC
- **Contact Material** .....AgNi10+0.2µmAu Standard  
.....AgCdO+0.2µmAu, AgNi10+5µmAu Optional
- **Mechanical Life** .....50x10<sup>6</sup> operation cycles
- **Electrical Life**.....AgCdO >2x10<sup>5</sup>, AgNi10 >10<sup>5</sup>  
.....operation cycles @ 230V AC, 6A, cos φ=1
- **Ambient Temperature**.....-40...+60°C (85°C)\*
- **Cover Material** .....Polyamide 6
- **Weight**.....15 g

## Diagrams

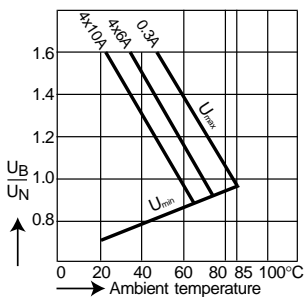

Relay operation voltage vs. ambient temperature

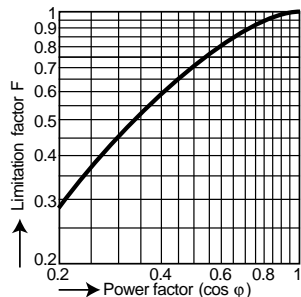

Limitation factor for inductive loads  
Operations = Operations (ohmic) x limitation factor F

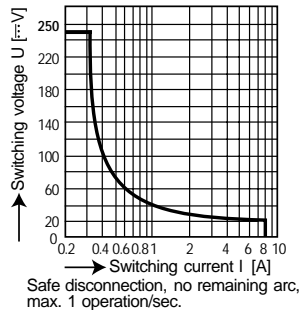

Maximum switching power curve  
Safe disconnection, no remaining arc, max. 1 operation/sec.

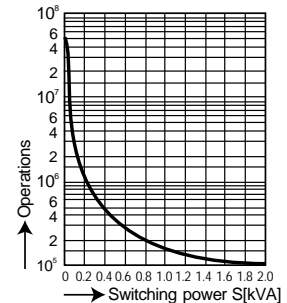

Mechanical life

# Safety Relay 5669 Data

Relay Data			Ordering Information			
Rated Voltage	Voltage Range	Coil Resistance	1 NO/1 NC Type	2 CO Type	2 NO Type	2 NC Type
5V	4.0 - 8.0V	36 Ω	56.O□69.0511□	56.O□69.0500□	56.O□69.0520□	56.O□69.0502□
6V	4.8 - 9.6V	50 Ω	56.O□69.0611□	56.O□69.0600□	56.O□69.0620□	56.O□69.0602□
12V	9.6 - 19.2V	210 Ω	56.O□69.1211□	56.O□69.1200□	56.O□69.1220□	56.O□69.1202□
20V	16.0 - 32.0V	580 Ω	56.O□69.2011□	56.O□69.2000□	56.O□69.2020□	56.O□69.2002□
24V	19.2 - 38.4V	820 Ω	56.O□69.2411□	56.O□69.2400□	56.O□69.2420□	56.O□69.2402□
48V	38.4 - 76.8V	3200 Ω	56.O□69.4811□	56.O□69.4800□	56.O□69.4820□	56.O□69.4802□
60V	48.0 - 96.0V	5200 Ω	56.O□69.6011□	56.O□69.6000□	56.O□69.6020□	56.O□69.6002□
110V	88.0 - 176.0V	20000 Ω	56.O□69.1111□	56.O□69.1100□	56.O□69.1120□	56.O□69.1102□

Protection Class, Example:

**A** IP 40, Flow Solder Proof

**W** IP 67, Washable

Contact Material, Example:

**C** AgCdO+.2μmAu

**N** AgNi10+.2μmAu

**S** AgNi10+5μmAu

## Footprints

(Note: Shown at their actual size.)

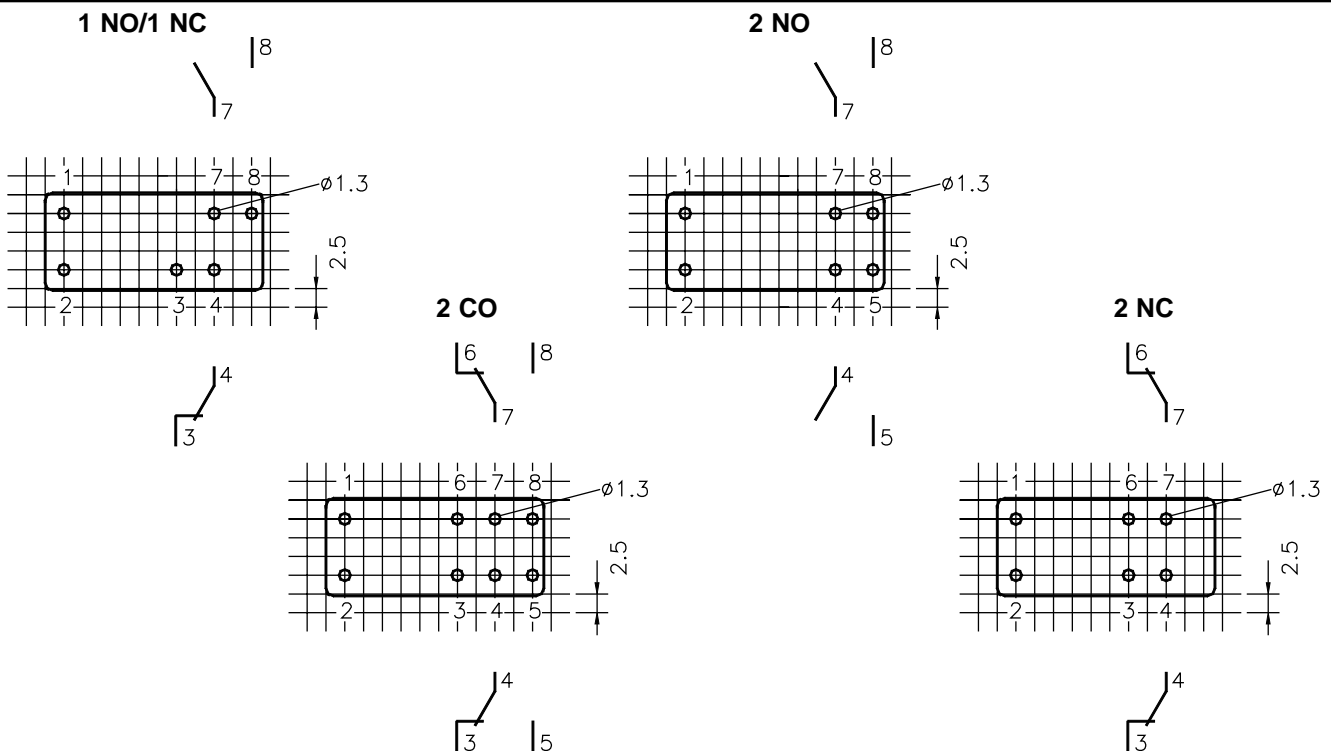

## Dimensions

(Note: Shown at their actual size.)

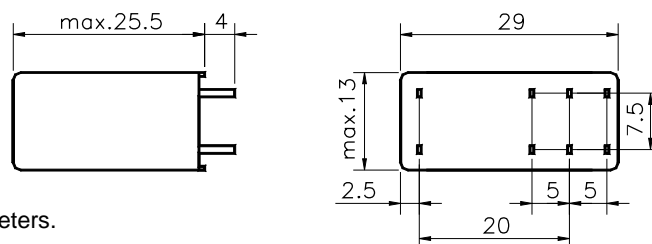

Note: All dimensions are shown in millimeters.  
To convert to inches, divide by 25.4.

# Safety Relay

## OA 5667, OA5667S

### Features

- 2 output contacts
- International approvals: TÜV, UL, cUL
- Quality control check for each safety relay
- Forced-guided contacts, all gold flash plated
- Contact Gap > 0.5 mm throughout life of relay
- Various contact materials, mixed contact material optional
- High coil voltage range
- High breakdown Voltage:
  - contact/coil  $\geq$  4 KV
  - contact/contact  $\geq$  2.5 KV
  - contact/contact  $\geq$  4 KV; S-Type
- High Creeping Distance:
  - contact/coil > 8 mm
  - contact/contact > 5.5 mm; S-Type
- Custom design available,
  - coil voltage            -coil resistance,
  - contact pressure    -operate/release time

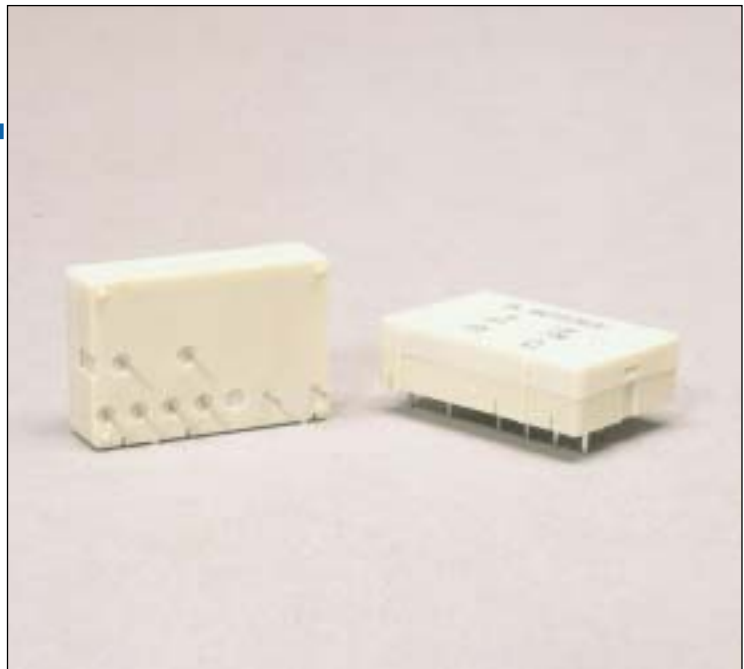

GERMANY



USA/CANADA

## Technical Data

- **Nominal Coil Voltage** .....5, 6, 12, 20, 24, 48, 60, 110 DC
- **Coil Power Dissipation** .....0.75 W
- **Max. Switching Voltage** .....250V DC, 400V AC
- **Max. Switching Current** .....6A (2 x 6A simultaneous)
- **Max. Switching Power — DC** .....200W (2 x 160W simultaneous)
- **Max. Switching Power — AC** .....1500VA (2 x 1500VA simultaneous)
- **Contact Switching Rate** .....10 operations per second
- **Relay Operate Time** .....10 ms
- **Relay Release Time** .....6 ms
- **Operation Vibration** .....0.35 mm Ampl. max @ 10...100Hz, 4g max
- **Contact Arrangements** .....1 NO/1 NC, 2CO
- **Contact Material** .....AgNi10+0.2 $\mu$ mAu Standard AgCdO+0.2 $\mu$ mAu, AgNi10+5 $\mu$ mAu Optional
- **Mechanical Life** ..... $\geq 10^7$  operation cycles
- **Electrical Life** .....AgCdO  $> 2 \times 10^5$ , AgNi10  $> 10^5$  operation cycles @ 250V AC, 6A,  $\cos \phi = 1$
- **Ambient Temperature** .....-25...+70°C
- **Protection Rating** .....IP40
- **Cover Material** .....Thermoplast
- **Weight** .....16 g

## Diagrams

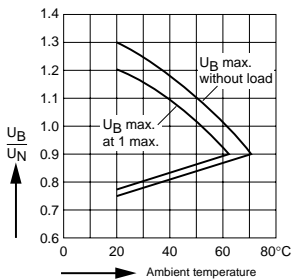

Relay operation voltage vs. ambient temperature

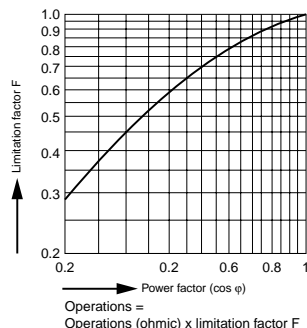

Limitation factor for inductive loads

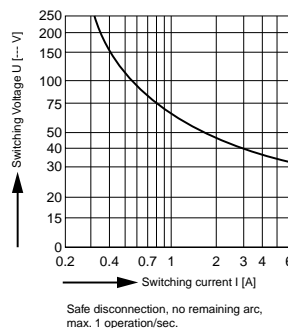

Maximum switching power curve

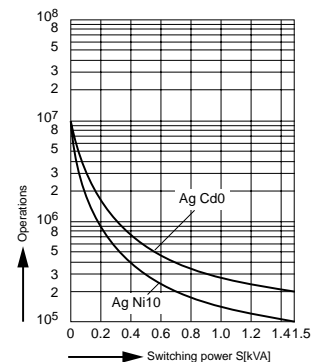

Mechanical life

# Safety Relay 5667/5667S Data

## Relay Data

Rated Voltage	Voltage Range	Coil Resistance	1 NO/1 NC Type	2 CO Type	1 NO/1 NC S-Type	2 CO S-Type
5V	3.75- 6.5V	33 Ω	56.OA67.0511□	56.OA67.0500□	56.OA67S.0511□	56.OA67S.0500□
6V	4.5 - 7.8V	48 Ω	56.OA67.0611□	56.OA67.0600□	56.OA67S.0611□	56.OA67S.0600□
12V	9.0 - 15.6V	183 Ω	56.OA67.1211□	56.OA67.1200□	56.OA67S.1211□	56.OA67S.1200□
20V	15.0- 26.0V	530 Ω	56.OA67.2011□	56.OA67.2000□	56.OA67S.2011□	56.OA67S.2000□
24V	18.0 - 31.2V	750 Ω	56.OA67.2411□	56.OA67.2400□	56.OA67S.2411□	56.OA67S.2400□
48V	36.0 - 62.4V	3200 Ω	56.OA67.4811□	56.OA67.4800□	56.OA67S.4811□	56.OA67S.4800□
60V	45.0 - 78.0V	4700 Ω	56.OA67.6011□	56.OA67.6000□	56.OA67S.6011□	56.OA67S.6000□
110V	82.5 - 143.5V	15300 Ω	56.OA67.1111□	56.OA67.1100□	56.OA67S.1111□	56.OA67S.1100□

## Ordering Information

Contact Material, Example: CAgCdO+.2μmAu  
NAgNi10+.2μmAu  
SAgNi10+5μmAu

## Footprints

(Note: Shown at their actual size.)

### 2 CO

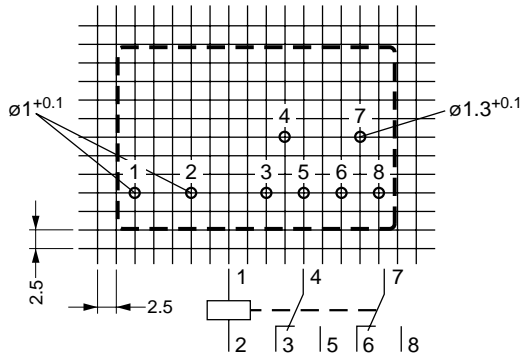

### 2 CO S-Type

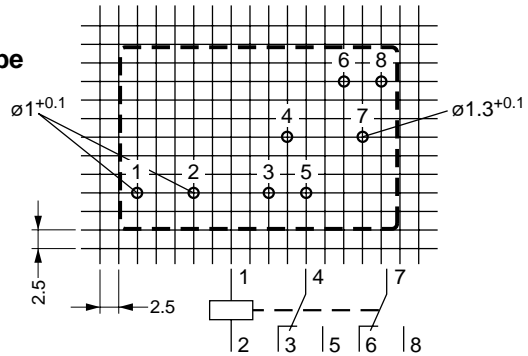

### 1 NO/1 NC

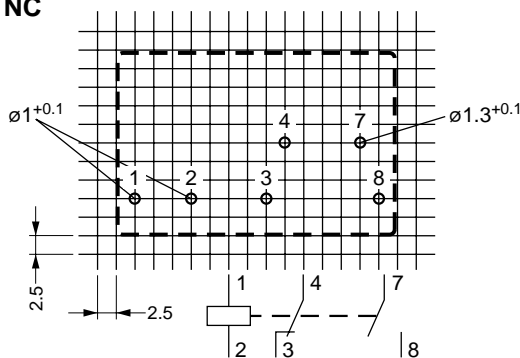

### 1 NO/1 NC S-Type

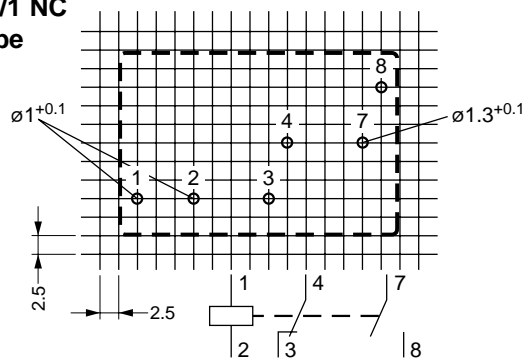

## Dimensions

Note: All dimensions are shown in millimeters.  
 To convert to inches, divide by 25.4.

### 2 CO

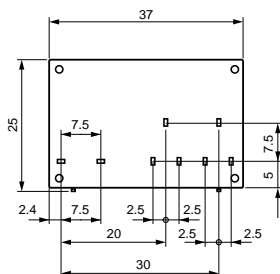

### 1 NO/1 NC

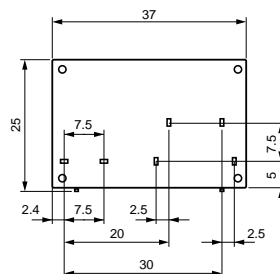

### 2 CO, S-Type

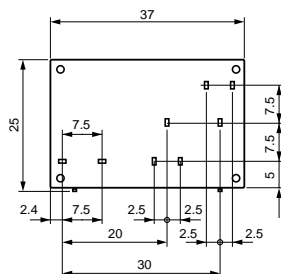

### 1 NO/1 NC, S-Type

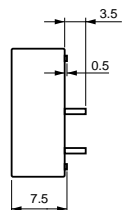
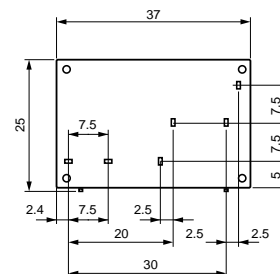

# Safety Relay

## OA 5611

### Features

- 4 output contacts
- International approvals: TÜV, UL, cUL, CSA
- Quality control check for each safety relay
- Forced-guided contacts, all gold flash plated
- Contact Gap > 0.5 mm throughout life of relay
- Various contact materials, mixed contact material optional
- High coil voltage range
- High switching voltage
- High breakdown voltage: contact/coil > 4 KV
- High creeping distance: contact/coil > 8 mm
- Crown contacts
- Solid connection between coil and contact housing
- Compact size
- Custom design available,
  - coil voltage -IP67 washable
  - contact pressure -coil resistance
  - operate/release time
  - low power dissipation models
  - Manual test relay (slide activated)



GERMANY



USA/CANADA



CANADA

### Technical Data

- **Nominal Coil Voltage** .....6, 12, 24, 48, 60, 110, DC
- **Coil Power Dissipation** .....0.6 W
- **Max. Switching Voltage** .....250V DC, 400 V AC
- **Max. Switching Current** .....8 A
- **Max. Switching Power — DC**.....200W
- **Max. Switching Power — AC**.....2000VA
- **Contact Switching Rate** .....10 operations per second
- **Relay Operate Time** .....20 ms
- **Relay Release Time** .....6 ms
- **Operation Vibration** .....0.35 mm Ampl. max @ 10...200Hz, 3g max
- **Protection Rating** .....IP 40
- **Contact Arrangements** .....2NO/2NC, 3NO/1NC
- **Contact Material**.....AgNi10+0.2µmAu, AgCdO+0.2µmAu, AgNi10+5µmAu
- **Mechanical Life** .....50x10<sup>6</sup> operation cycles
- **Electrical Life**.....AgCdO >3x10<sup>5</sup>, AgNi10 >2x10<sup>5</sup> operation cycles @ 230V AC, 5A, cos φ=1  
AgCdO >1.5x10<sup>5</sup>, AgNi10 >10<sup>5</sup> operation cycles @ 230V AC, 8A, cos φ=1
- **Ambient Temperature**.....-25...+85°C
- **Cover Material**.....Thermoplast
- **Weight**.....35 g

### Diagrams

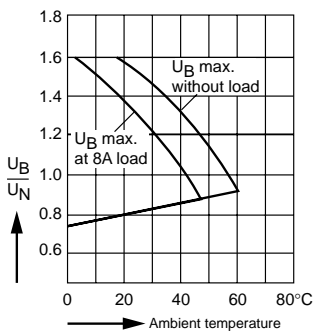

Relay operation voltage vs. ambient temperature

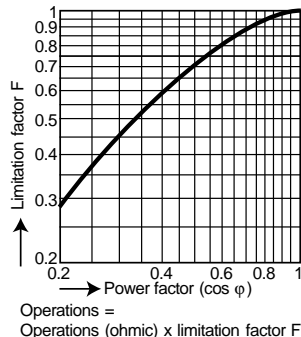

Limitation factor for inductive loads

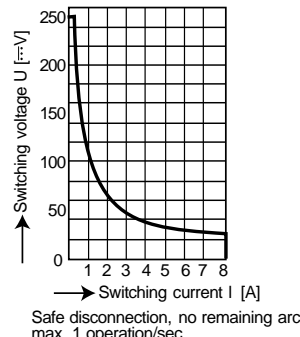

Maximum switching power curve

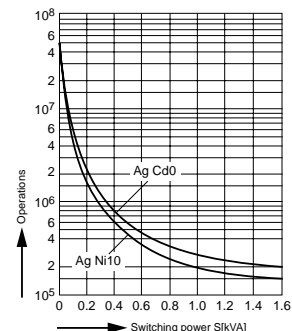

Mechanical life

# Safety Relay 5611 Data

Relay Data			Ordering Information	
Rated Voltage	Voltage Range	Coil Resistance	2 NO/2 NC Type	3 NO/1 NC Type
6V	4.2 - 8.4V	56 Ω	56.OA11.0622□	56.OA11.0631□
12V	8.4 - 16.8V	240 Ω	56.OA11.1222□	56.OA11.1231□
24V	16.8 - 33.6V	960 Ω	56.OA11.2422□	56.OA11.2431□
48V	33.6 - 67.2V	3840 Ω	56.OA11.4822□	56.OA11.4831□
60V	42.0 - 84.0V	6000 Ω	56.OA11.6022□	56.OA11.6031□
110V	77.0 - 154.0V	20150 Ω	56.OA11.1122□	56.OA11.1131□

Contact Material, Example:   
CAgCdO+.2μmAu   
NAgNi10+.2μmAu   
SAgNi10+5μmAu

## Footprints

(Note: Shown at their actual size.)

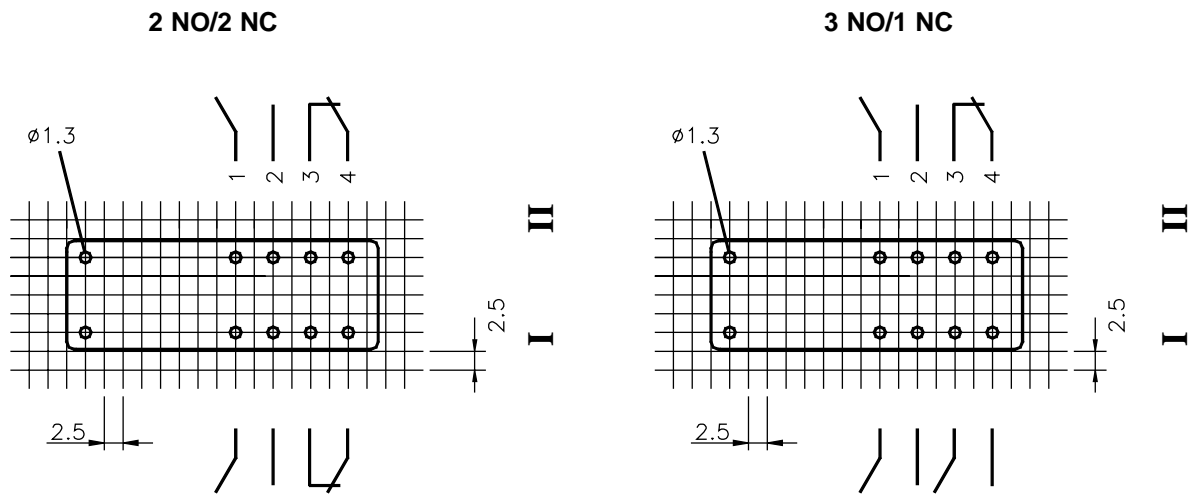

## Dimensions

(Note: Shown at their actual size.)

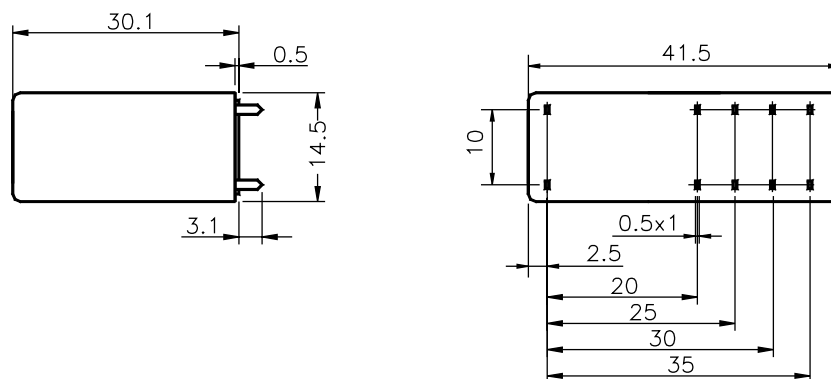

Note: All dimensions are shown in millimeters. To convert to inches, divide by 25.4.

# Safety Relay

## OA 5612

### Features

- 6 output contacts
- International approvals: TÜV, UL, cUL, CSA
- Quality control check for each safety relay
- Forced-guided contacts, all gold flash plated
- Contact Gap > 0.5 mm throughout life of relay
- Various contact materials, mixed contact material optional
- High coil voltage range
- Very high switching voltage
- High breakdown voltage: contact/coil > 4 KV
- High creeping distance: contact/coil > 8 mm
- Crown contacts
- Solid connection between coil and contact housing
- Compact size
- Custom design available,
  - coil voltage -IP67 washable
  - contact pressure -coil resistance
  - operate/release time
  - low power dissipation models



GERMANY



USA/CANADA



CANADA

### Technical Data

- **Nominal Coil Voltage** .....6, 12, 24, 48, 60, 110, DC
- **Coil Power Dissipation**.....0.8 - 1.0 W
- **Max. Switching Voltage** .....250V DC, 400V AC
- **Max. Switching Current** .....8 A
- **Max. Switching Power—DC** .....200W
- **Max. Switching Power—AC** .....2000VA
- **Contact Switching Rate** .....10 operations per second
- **Relay Operate Time** .....20 ms
- **Relay Release Time** .....6 ms
- **Operation Vibration** .....0.35 mm Ampl. max  
.....@ 10...200Hz, 3g max
- **Protection Rating** .....IP 40
- **Contact Arrangements**.....2NO/4NC, 3NO/3NC, 4NO/2NC
- **Contact Material**.....AgNi10+0.2µmAu, AgCdO+0.2µmAu, AgNi10+5µmAu
- **Mechanical Life** .....50x10<sup>6</sup> operation cycles
- **Electrical Life** .....AgCdO >3x10<sup>5</sup>, AgNi10 >2x10<sup>5</sup>  
.....operation cycles @ 230V AC, 5A, cos φ=1  
.....AgCdO >1.5x10<sup>5</sup>, AgNi10 >10<sup>5</sup>  
.....operation cycles @ 230V AC, 8A, cos φ=1
- **Ambient Temperature**.....-25...+85°C
- **Cover Material**.....Thermoplast
- **Weight**.....38 g

### Diagrams

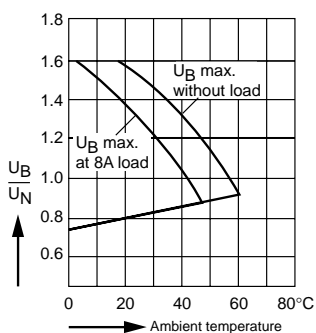

Relay operation voltage vs. ambient temperature

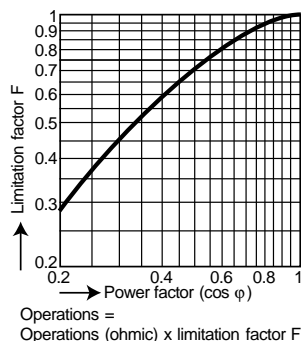

Limitation factor for inductive loads

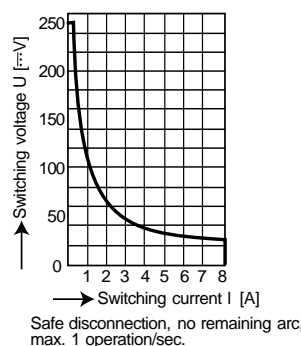

Maximum switching power curve

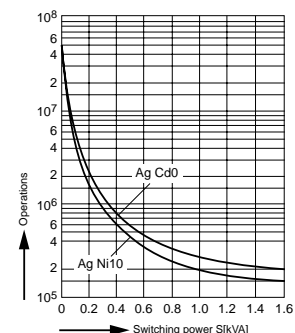

Mechanical life

# Safety Relay 5612 Data

Relay Data				Ordering Information			
Rated Voltage	Voltage Range	Coil Resistance	2 NO/4 NC Type	Coil Resistance	3 NO/3 NC Type	4 NO/2 NC Type	
6V	4.2 - 8.4V	36 Ω	56.OA12.0624□	45 Ω	56.OA12.0633□	56.OA12.0642□	
12V	8.4 - 16.8V	145 Ω	56.OA12.1224□	180 Ω	56.OA12.1233□	56.OA12.1242□	
24V	16.8 - 33.6V	600 Ω	56.OA12.2424□	720 Ω	56.OA12.2433□	56.OA12.2442□	
48V	33.6 - 67.2V	2300 Ω	56.OA12.4824□	2880 Ω	56.OA12.4833□	56.OA12.4842□	
60V	42.0 - 84.0V	3600 Ω	56.OA12.6024□	4500 Ω	56.OA12.6033□	56.OA12.6042□	
110V	77.0 - 154.0V	12100 Ω	56.OA12.1124□	15125 Ω	56.OA12.1133□	56.OA12.1142□	

Contact Material, Example: CAgCdO+.2μmAu  
NAgNi10+.2μmAu  
SAgNi10+5μmAu

## Footprints (Note: Shown at their actual size.)

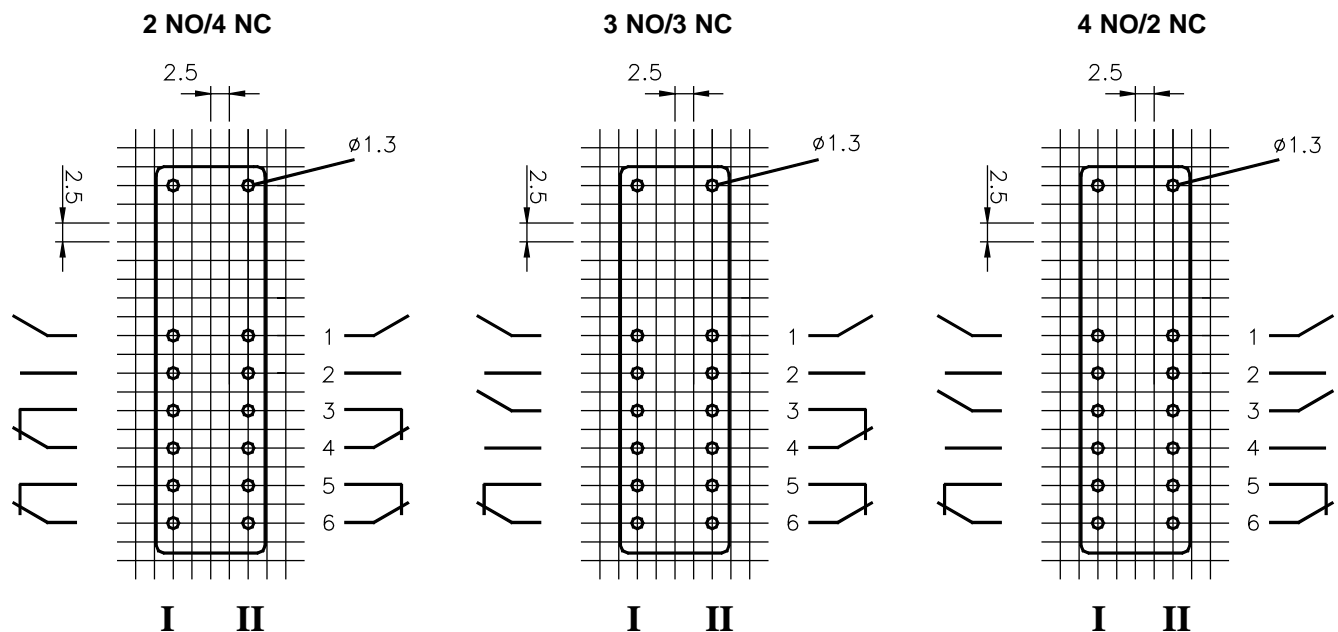

## Dimensions (Note: Shown at their actual size.)

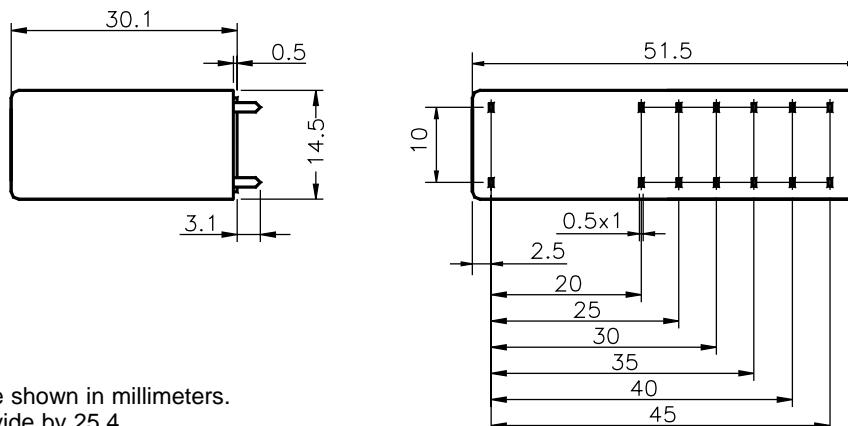

Note: All dimensions are shown in millimeters. To convert to inches, divide by 25.4.

# Safety Relay

## OA 5603

### Features

- 8 output contacts
- International approvals: TÜV, UL, cUL, CSA
- Quality control check for each safety relay
- Forced-guided contacts, all gold flash plated
- Contact gap > 0.5 mm throughout life of relay
- Various contact materials, mixed contact material optional
- High coil voltage range
- Very high and low switching current
- High switching voltage
- High breakdown voltage: contact/coil > 4 KV
- High creeping distance: contact/coil > 8 mm
- Crown contacts
- Solid connection between coil and contact housing
- Custom design available,
  - coil voltage
  - coil resistance,
  - contact pressure
  - operate/release time



GERMANY



USA/CANADA



CANADA

## Technical Data

- **Nominal Coil Voltage** ..... 6, 12, 24, 48, 60, 110, DC
- **Coil Power Dissipation** ..... 1.25 - 1.65 W
- **Max. Switching Voltage** ..... 250V DC, 400V AC
- **Max. Switching Current** ..... 10 A
- **Max. Switching Power—DC** ..... 240W
- **Max. Switching Power—AC** ..... 2500VA
- **Contact Switching Rate** ..... 10 operations per second
- **Relay Operate Time** ..... 27 ms
- **Relay Release Time** ..... 5 ms
- **Operation Vibration** ..... 0.35 mm Ampl. max @ 10...55Hz
- **Protection Rating** ..... IP 40
- **Contact Arrangements** ..... 2NO/6NC, 3NO/5NC, 4NO/4NC, 5NO/3NC, 6NO/2NC, 7NO/1NC
- **Contact Material** ..... AgCdO+0.2µmAu, AgNi10+0.2µmAu, AgNi10+5µmAu
- **Mechanical Life** ..... 30x10<sup>6</sup> Operation cycles
- **Electrical Life** ..... AgCdO >7x10<sup>5</sup>, AgNi10 >5x10<sup>5</sup> operation cycles @ 230V AC, 5A, cos φ=1  
 ..... AgCdO >3x10<sup>5</sup>, AgNi10 >2x10<sup>5</sup> operation cycles @ 230V AC, 10A, cos φ=1
- **Ambient Temperature** ..... -25...+75°C
- **Cover Material** ..... Thermoplast
- **Weight** ..... 95 g

## Diagrams

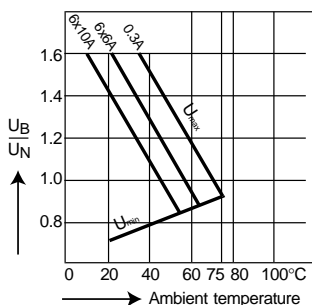

Relay operation voltage vs. ambient temperature

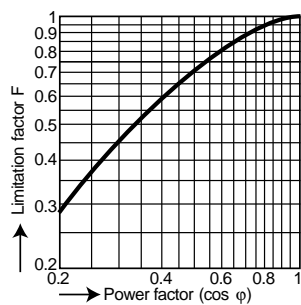

Limitation factor for inductive loads  
 Operations =  
 Operations (ohmic) x limitation factor F

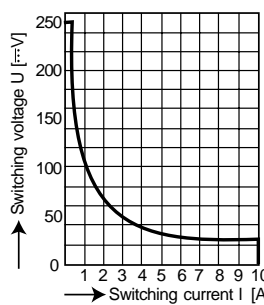

Maximum switching power curve  
 Safe disconnection, no remaining arc,  
 max. 1 operation/sec.

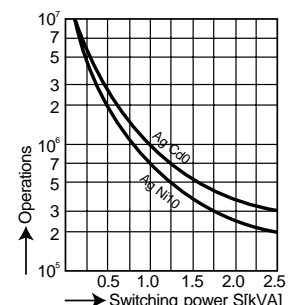

Mechanical life

**SAFETY RELAY MODULES**  
**8 Amp Contacts,**  
**35 or 32mm DIN Rail**

**Isolated Channel**  
**Double Pole Double Throw**

**Bussed Channel**  
**Double Pole Double Throw**

Altech Safety Relay Modules utilize Relays with Force-Guided-Contacts that meet or exceed international standards, TÜV, SA, SUVA, and UL. They are designed to protect man and machine as specified in OSHA FR1910 Regulations, a mandatory requirement of the European Machinery Directive EMD 89.392 EEC. The Safety Relays are used in Safety Devices such as Emergency Stop Modules, Safety Gate Monitors, 2-Hand Safety Modules, etc.

This series of Safety Relay Modules are Double Pole, Double Throw configurations, and are available as 1, 2, 4, 8 and 16 isolated channels and 8 and 16 bussed channels with 12 or 24 VDC coils. Isolated channels allow control of each relay by a different logic system, if necessary. There are two inputs for each relay coil per channel. Bussed channels allow high density packaging with a common input for all relays. Safety Relay Modules may be ordered with three different types of relay contact material, depending on the actual load current.

- Screw-Cage Clamp Connection
- LED Coil Voltage Indicator
- Reverse DC Polarity LED Protection
- Surge Suppression With DC Coils
- Industry Standard Relays
- DIN Rail Mount, Panel Mount Available

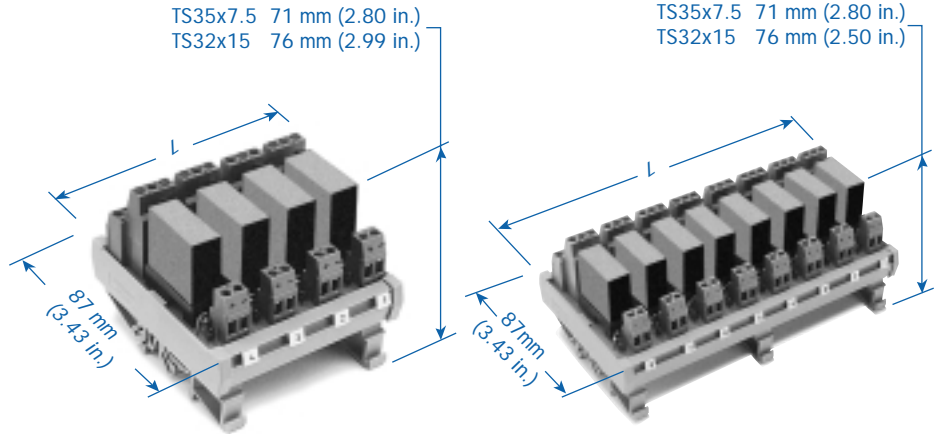

<i>Isolated Channels (No Bus)</i>	<i>Length (L) mm (in.)</i>	<i>Type/Cat. No.</i>	<i>Type/ Cat. No.</i>	<i>Type/Cat. No.</i>
<b>1 Channel, Coil Voltage</b>	21 (0.83)			
12V		8949.2C	8949.2N	8949.2S
24V		8951.2C	8951.2N	8951.2S
<b>2 Channel, Coil Voltage</b>	40 (1.57)			
12V		8949.3C	8949.3N	8949.3S
24V		8951.3C	8951.3N	8951.3S
<b>4 Channel, Coil Voltage</b>	79 (3.11)			
12V		8955.2C	8955.2N	8955.2S
24V		8956.2C	8956.2N	8956.2S
<b>8 Channel, Coil Voltage</b>	157 (6.18)			
12V		8955.3C	8955.3N	8955.3S
24V		8956.3C	8956.3N	8956.3S
<b>16 Channel, Coil Voltage</b>	311 (12.24)			
12V		8963.2C	8963.2N	8963.2S
24V		8972.2C	8972.2N	8972.2S
<i>Bussed Channels</i>	<i>Length (L) mm (in.)</i>	<i>Type/Cat. No.</i>	<i>Type/Cat. No.</i>	<i>Type/Cat. No.</i>
<b>8 Channel, Bussed DC+</b>	125 (4.92)			
12V		8923.2C	8923.2N	8923.2S
24V		8924.2C	8924.2N	8924.2S
<b>8 Channel, Bussed DC-</b>	125 (4.92)			
12V		8923.3C	8923.3N	8923.3S
24V		8924.4C	8924.4N	8924.4S
<b>16 Channel, Bussed DC+</b>	248 (9.76)			
12V		8926.2C	8926.2N	8926.2S
24V		8926.3C	8926.3N	8926.3S
<b>16 Channel, Bussed DC-</b>	248 (9.76)			
12V		8927.2C	8927.2N	8927.2S
24V		8927.3C	8927.3N	8927.3S

<b>Contact Material:</b> AgCdO+0.2µmAu	<b>Contact Material:</b> AgNi10+0.2µmAu	<b>Contact Material:</b> AgNi10+5µmAu
<b>Contact Ratings:</b> 8A(2x5A) 110DC, 250VAC	<b>Contact Ratings:</b> 8A(2x5A) 110DC, 250VAC	<b>Contact Ratings:</b> 8A(2x5A) 110DC, 250VAC

## Isolated Channel, DPDT

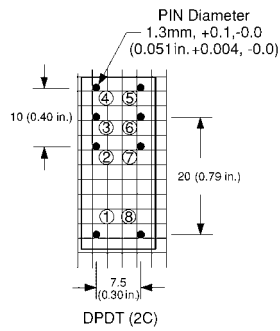

Bottom View, Relay Pinouts, Grid 2.54mm (0.1in.)

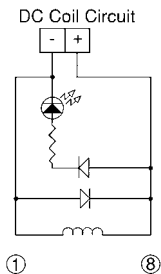

① ⑧

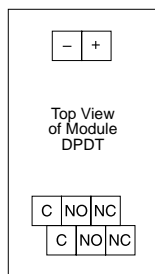

Top View of Module DPDT

## Bussed Channel, DPDT

### Relay Pinout

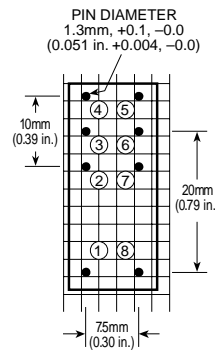

### Coil Circuits

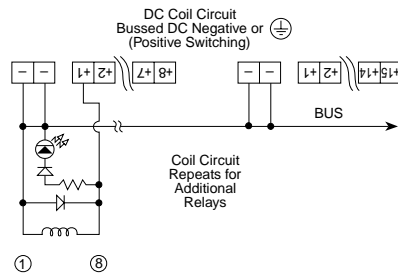

① ⑧

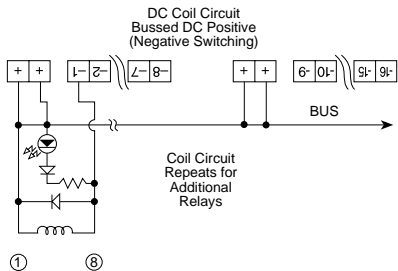

① ⑧

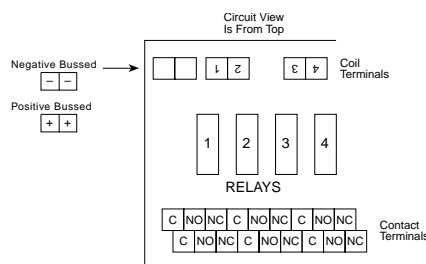

Circuit View Is From Top

Negative Bussed

Positive Bussed

Coil Terminals

RELAYS

Contact Terminals

### Contact Circuits

For Both Isolated and Bussed Channels

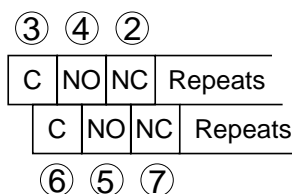
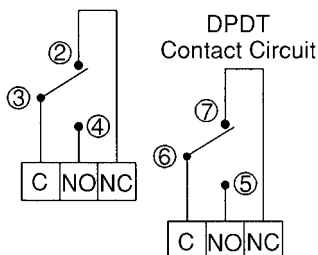

## Relay Specifications

-Normal Coil Voltage:	12,24 VDC
-Coil Power Dissipation:	0.7W
-Max. Switching Voltage:	110VDC, 250VAC
-Max. Switching Current:	8A(2x5A simultaneous)
-Max. Switching Power:	
DC	200W (2x160W simultaneous)
AC	2000VA (2x1250VA simultaneous)
-Contact Switching Rate:	10 operations/ sec.
-Relay Operate Time	15 ms
-Relay Release Time	12 ms
-Contact Arrangements	DPDT, 2 FORM C
-Contact Material:	
Standard	AgNi10+0.2μmAu
Optional	AgCdO+0.2μmAu AgNi10+5μmAu
-Mechanical Life:	50x10 <sup>6</sup> operation cycles
-Ambient Temperature:	-40° + 60°C
-Cover Material:	Polyamide 6
-Weight:	15g

## Coil Specifications

Rated Voltage	Voltage Range	Coil Resistance
12VDC	9.6V-19.2V	210Ω ± 15%
24VDC	19.2V-38.4V	820Ω ± 15%

**SAFETY RELAY MODULES**  
**4 Pole Relays, 8 or 10 Amps**

Altech Safety Relay Modules utilize Relays with Force-Guided-Contacts that meet or exceed international standards, TÜV, SA, SUVA, and UL. They are designed to protect man and machine as specified in OSHA CFR1910 Regulations, which is a mandatory requirement of the European Machinery Directive EMD 89.392 EEC.

Altech Safety Relays are electro-mechanical relays that are mechanically linked together, causing all contacts to move together when the coil is energized. Force-Guided-contacts are also known as positive-guided-contacts, captive contacts or locked contacts. In addition, our Safety Relays have Crown Contacts which provide two locations per contacts to improve switching conditions. The Safety Relays are used in Safety Devices such as Emergency Stop Modules, Safety Gate Monitors, 2-Hand Safety Modules, Safety Light Curtains, etc.

This series of Safety Relay Modules consist of 4 pole relays with two choices of configurations (2NO/2NC or 3NO/1NC), with 8 or 10 Amp contacts, and are available as 1,2, and 4 isolated channels with 12, or 24 VDC coils. Isolated channels allows control of each relay by a different logic system, if necessary. There are two inputs for each relay coil per channel. Safety Relay Modules may be ordered with three different types of relay contact material, depending on the actual load current. The part numbers shown in this data sheet are for our standard contact material, which is AgCd0 + 0.2µmAu.

- Screw-Cage clamp Connections
- LED Coil Voltage Indicator
- Reverse DC Polarity LED Protection
- Surge Suppression With DC Coil
- Din Rail Mount, Panel Mount Available

**4 Pole, 8 Amp**

**4 Pole, 10 A**

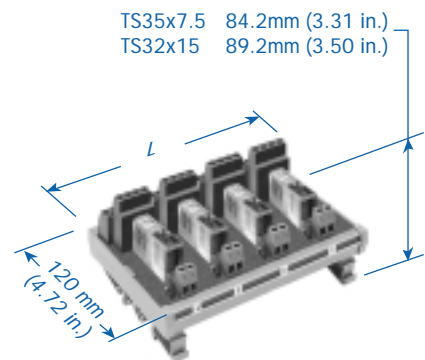
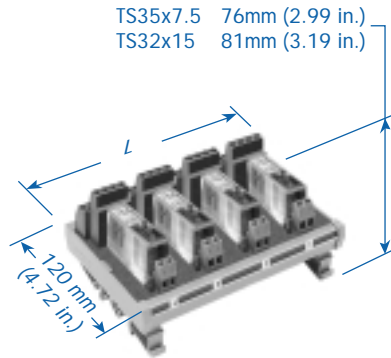

Ordering Information	Length (L) mm (in.)
1 Channel, Coil Voltage 12V 24V	40.10 (1.58)
2 Channel, Coil Voltage 12V 24V	78.20 (3.08)
4 Channel, Coil Voltage 12V 24V	154.40 (6.08)

Contact Material*: AgCd0 + 0.2µmAu	
Contact Ratings: 8A(2x5A) 250VDC, 400VAC	
Contacts:	
2N.O + 2N.C	3N.O + 1N.C
Type/ Cat. No.	Type/ Cat. No.
156.0A11.1222C 156.0A11.2422C	156.0A11.1231C 156.0A11.2431C
256.0A11.1222C 256.0A11.2422C	256.0A11.1231C 256.0A11.2431C
456.0A11.1222C 456.0A11.2422C	456.0A11.1231C 456.0A11.2431C

Contact Material*: AgCd0 + 0.2µmAu	
Contact Ratings: 10A(2x5A) 250VDC, 400VAC	
Contacts:	
2N.O + 2N.C	3N.O + 1N.C
Type/ Cat. No.	Type/ Cat. No.
156.0A01.1222C 156.0A01.2422C	156.0A01.1231C 156.0A01.2431C
256.0A01.1222C 256.0A01.2422C	256.0A01.1231C 256.0A01.2431C
456.0A01.1222C 456.0A01.2422C	456.0A01.1231C 456.0A01.2431C

\* Note: Additional relay contact materials are available upon request. Please contact Altech for additional information.

## 4 Pole, 8 Amps

## 4 Pole, 10 Amps

### DC Coil Circuits

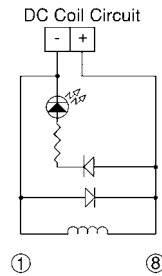
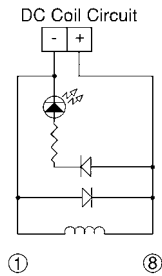

### Contact Circuits

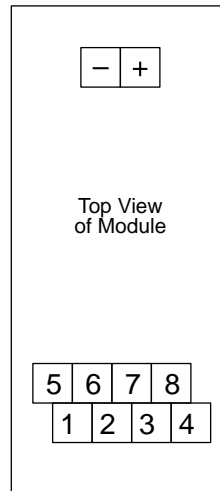
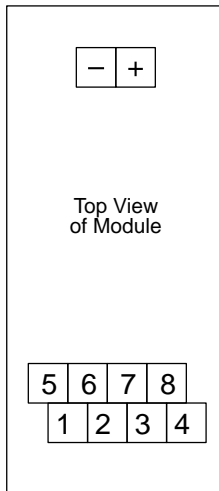

#### Relay Configurations

2 N.O + 2 N.C  
NO Pin (1,2), (5,6)  
NC Pin (3,4), (7,8)

3 N.O + 1 N.C

NO Pin (1,2), (5,6), (7,8)  
NC Pin (3,4)

#### Relay Configurations

2 N.O + 2 N.C  
NO Pin (3,4), (7,8)  
NC Pin (1,2), (5,6)

3 N.O + 1 N.C

NO Pin (3,4), (5,6), (7,8)  
NC Pin (1,2)

## Relay Specifications - 8 Amps

-Normal Coil Voltage:	12,24 VDC
-Coil Power Dissipation:	0.6W
-Max. Switching Voltage:	250VDC, 400VAC
-Max. Switching Current:	8A
-Max. Switching Power	
DC	200W
AC	2000VA
-Contact Switching Rate:	10 operations/ sec.
-Relay Operate Time	20 ms
-Relay Release Time	6 ms
-Contact Arrangements	2NO/2NC, 3NO/1NC
-Contact Material:	
Standard	AgCdO+0.2µmAu
Optional	AgNi10+0.2µmAu AgNi10+5µmAu
-Mechanical Life:	50x10 <sup>6</sup> operation cycles
-Ambient Temperature:	-25° + 85°C
-Cover Material:	Thermoplast
-Weight:	35g

## Coil Specifications

Rated Voltage	Voltage Range	Coil Resistance
12VDC	8.4V-16.8V	240Ω ± 15%
24VDC	16.8V-33.6V	960Ω ± 15%

## Relay Specifications - 10 Amps

-Normal Coil Voltage:	12,24 VDC
-Coil Power Dissipation:	0.75W
-Max. Switching Voltage:	250VDC, 400VAC
-Max. Switching Current:	10A
-Max. Switching Power	
DC	240W
AC	2500VA
-Contact Switching Rate:	10 operations/ sec.
-Relay Operate Time	27 ms
-Relay Release Time	5 ms
-Contact Arrangements	2NO/2NC, 3NO/1NC
-Contact Material:	
Standard	AgCdO+0.2µmAu
Optional	AgNi10+0.2µmAu AgNi10+5µmAu
-Mechanical Life:	30x10 <sup>6</sup> operation cycles
-Ambient Temperature:	-25° + 80°C
-Cover Material:	Thermoplast
-Weight:	75g

## Coil Specifications

Rated Voltage	Voltage Range	Coil Resistance
12VDC	8.4V-19.2V	192Ω ± 15%
24VDC	16.8V-38.4V	770Ω ± 15%

**SAFETY RELAY MODULES**  
**6 Pole Relays, 8 or 10 Amps**

**6 Pole, 8 Amps**

**6 Pole, 10 Amps**

Altech Safety Relay Modules utilize Relays with Force-Guided-Contacts that meet or exceed international standards, TÜV, SA, SUVA, and UL. They are designed to protect man and machine as specified in OSHA CFR1910 Regulations, which is a mandatory requirement of the European Machinery Directive EMD 89.392 EEC.

Altech Safety Relays are electro-mechanical relays that are mechanically linked together, causing all contacts to move together when the coil is energized. Force-Guided-contacts are also known as positive-guided-contacts, captive contacts or locked contacts. In addition, our Safety Relays have Crown Contacts which provides two locations per contacts to improve switching conditions. The Safety Relays are used in Safety Devices such as Emergency Stop Modules, Safety Gate Monitors, 2-Hand Safety Modules, Safety Light Curtains, etc.

This series of Safety Relay Modules consist of 6 pole relays with three configuration choices (2NO+4NC, 3NO+3NC, 4NO+2NC), 8 or 10 Amp contacts and either 1, 2 and 4 isolated channels with 12 or 24 VDC coils. Isolated channels allow control of each relay by a different logic system, if necessary. There are two inputs for each relay coil channel. Modules can be ordered with three contact materials, dependent upon the actual current load. The standard contact material is AgCdO+0.2µmAu.

- Screw-Cage clamp Connections
- LED Coil Voltage Indicator
- Reverse DC Polarity LED Protection
- Surge Suppression With DC Coil
- Din Rail Mount, Panel Mount Available

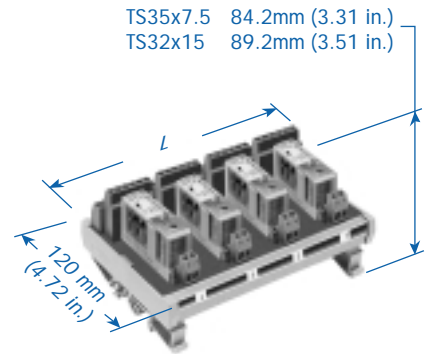
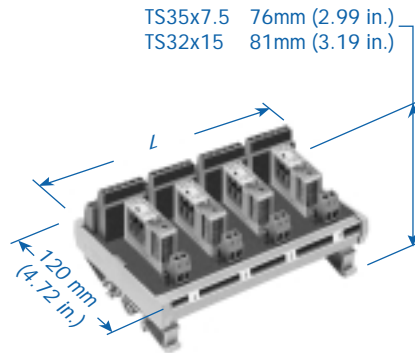

Ordering Information	Length (L) mm (in.)
<b>1 Channel, Coil Voltage</b> 12V 24V	46.45 (1.83)
<b>2 Channel, Coil Voltage</b> 12V 24V	90.90 (3.58)
<b>4 Channel, Coil Voltage</b> 12V 24V	179.80 (7.08)

<b>Contact Material*:</b> AgCdO+0.2µmAu		
<b>Contact Ratings:</b> 8A(2x5A) 250VDC,400VAC		
<b>Contacts:</b>		
2N.O + 4N.C	3N.O + 3N.C	4N.O + 2N.C

<b>Contact Material*:</b> AgCdO+0.2µmAu		
<b>Contact Ratings:</b> 10A(2x5A) 250VDC,400VAC		
<b>Contacts:</b>		
2N.O + 4N.C	3N.O + 3N.C	4N.O + 2N.C

Type/ Cat. No.	Type/ Cat. No.	Type/ Cat. No.
156.0A12.1224C	156.0A12.1233C	156.0A12.1242C
156.0A12.2424C	156.0A12.2433C	156.0A12.2442C
256.0A12.1224C	256.0A12.1233C	256.0A12.1242C
256.0A12.2424C	256.0A12.2433C	256.0A12.2442C
456.0A12.1224C	456.0A12.1233C	456.0A12.1242C
456.0A12.2424C	456.0A12.2433C	456.0A12.2442C

Type/ Cat. No.	Type/ Cat. No.	Type/ Cat. No.
156.0A02.1224C	156.0A02.1233C	156.0A02.1242C
156.0A12.2424C	156.0A02.2433C	156.0A02.2442C
256.0A02.1224C	256.0A02.1233C	256.0A02.1242C
256.0A12.2424C	256.0A02.2433C	256.0A02.2442C
456.0A02.1224C	456.0A02.1233C	456.0A02.1242C
456.0A12.2424C	456.0A02.2433C	456.0A02.2442C

\* Note: Additional relay contact materials are available upon request. Please contact Altech for additional information.

## 6 Pole, 8 Amps

## 6 Pole, 10 Amps

### DC Coil Circuits

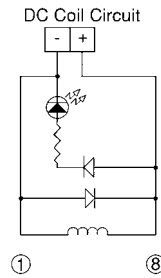
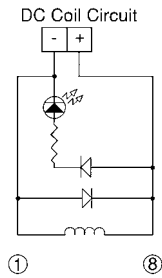

### Contact Circuits

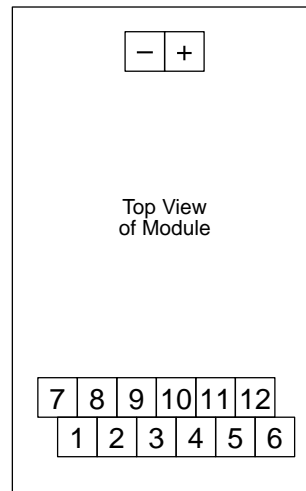
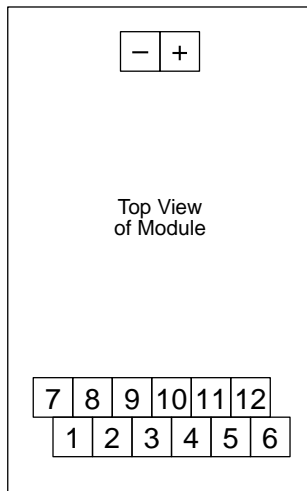

#### Relay Configurations

2N.O + 4N.C

NO Pin (1,2), (7,8)

NC Pin (3,4), (5,6), (9,10), (11,12)

3N.O + 3N.C

NO Pin (1,2), (7,8), (9,10)

NC Pin (3,4), (5,6), (11,12)

4N.O + 2N.C

NO Pin (1,2), (3,4), (7,8), (9,10)

NC Pin (5,6), (11,12)

#### Relay Configurations

2N.O + 4N.C

NO Pin (5,6), (11,12)

NC Pin (1,2), (3,4), (7,8), (9,10)

3N.O + 3N.C

NO Pin (3,4), (5,6), (11,12)

NC Pin (1,2), (7,8), (9,10)

4N.O + 2N.C

NO Pin (3,4), (5,6), (9,10), (11,12)

NC Pin (1,2), (7,8)

## Relay Specifications - 8 Amps

-Normal Coil Voltage: 12,24 VDC  
 -Coil Power Dissipation: 0.8-1.0 W  
 -Max. Switching Voltage: 250VDC, 400VAC  
 -Max. Switching Current: 8A

-Max. Switching Power  
 DC 200W (2x160W simultaneous)  
 AC 2000VA (2x1250VA simultaneous)

-Contact Switching Rate: 10 operations/ sec.  
 -Relay Operate Time 20 ms  
 -Relay Release Time 6 ms  
 -Contact Arrangements 2NO/4NC, 3NO/3NC, 4NO/2NC

-Contact Material:  
 Standard AgCdO+0.2µmAu  
 Optional AgNi10+0.2µmAu  
 AgNi10+5µmAu

-Mechanical Life: 50x10<sup>6</sup> operation cycles  
 -Ambient Temperature: -25° + 85°C  
 -Cover Material: Thermoplast  
 -Weight: 38g

### Coil Specifications

Rated Voltage	Voltage Range	Coil Resistance
12VDC	8.4V-16.8V	145Ω ± 15%
24VDC	16.8V-33.6V	600Ω ± 15%

## Relay Specifications - 10 Amps

-Normal Coil Voltage: 12,24 VDC  
 -Coil Power Dissipation: 1.0 W  
 -Max. Switching Voltage: 250VDC, 400VAC  
 -Max. Switching Current: 10A

-Max. Switching Power  
 DC 240W  
 AC 2500VA

-Contact Switching Rate: 10 operations/ sec.  
 -Relay Operate Time 27 ms  
 -Relay Release Time 5 ms  
 -Contact Arrangements 2NO/4NC, 3NO/3NC, 4NO/2NC

-Contact Material:  
 Standard AgCdO+0.2µmAu  
 Optional AgNi10+0.2µmAu  
 AgNi10+5µmAu

-Mechanical Life: 30x10<sup>6</sup> operation cycles  
 -Ambient Temperature: -25° + 80°C  
 -Cover Material: Thermoplast  
 -Weight: 85g

### Coil Specifications

Rated Voltage	Voltage Range	Coil Resistance
12VDC	8.4V-19.2V	140Ω ± 15%
24VDC	16.8V-38.4V	570Ω ± 15%

# Relay Terminology

**Ambient Temperature:** The temperature of the surrounding medium that comes in contact with the device/ equipment.

**Breakdown Voltage:** The minimum root-mean-square (rms) value of a sinusoidal voltage that results in sparkover.

**Coil, relay:** One or more windings on a common form.

**Coil Power Dissipation:** The amount of electric power consumed by a winding. For the most practical purpose, this equals the  $I^2R$  loss.

**Coil Resistance:** The total terminal-to-terminal resistance of a coil at a specified temperature.

**Contact Gap:** The final length of the isolating distance between mating contacts when the contacts are open.

**Contact Arrangement:** The combination of contact forms that make up the entire relay switching structure.

**Contact Housing:** The part that provides means for mounting fixed contacts on a supporting structure.

**Contact Material:** Substance or combination of substances used as constituents in the manufacture of the contacts.

**AgCdO + 0.2µmAu:** Silver-Cadmium Oxide with a 0.2µm layer of gold. Medium to high current applications for resistive, capacitive and particular inductive loads, 100mA-10A.

**AgNi10+ 0.2µmAu:** Silver-Nickel 10 with a 0.2µm layer of gold. Medium to high current applications, 15mA-10A.

**AgNi10+ 5µmAu:** Silver-Nickel 10 with a 5µm layer of gold. Low current applications only, where switching of very low current is crucial; 1mA-300mA, 100mV-60V.

**Contact Pressure:** Force exerted by one contact against the mating contact of a relay.

**Contact Switching Rate:** The velocity at which contact switching occurs, e.g., 10 switching operations per second.

**Corrosion:** The deterioration of a substance, usually a metal, because of a reaction with its environment.

**Cover Material:** Substance or combination of substances used as constituents in the manufacture of a protective covering used to enclose equipment.

**Creeping Distance:** The shortest distance between two conducting parts measured along the surface or joints of the insulating material between them.

## Safety Relay Selection Material Table

Material	Characteristics	Applications	Range
AgCdO + 0.2µmAu	very low welding tendency highest burn-up resistivity very good arc suppression	special for switching inductive loads	100mA - 10A
AgNi10 + 0.2µmAu	low welding tendency high burn-up resistivity good arc suppression	circuits with medium to high loads, DC current circuits	15mA - 10A
AgNi10 + 5µmAu	higher welding tendency low burn-up resistivity low contact resistance	where very low to medium switching current and voltage is mandatory	1mA - 300mA

**Crown Contacts:** Improved contact form to enforce high contact stress on at least two spots on the contact to penetrate any built-up contamination; to maintain low contact resistance throughout the life of a relay; and to increase the value of switchable output voltage. Supports low current to high power applications.

**Custom Design:** Special design to meet customer requirements regarding coil voltage, coil resistance, contact pressure, and relay operate/release time. Possible alteration of max. 3 specifications from the original standard value while the remaining 1 is retained at its original value.

## Graphic Symbols

Contact Name	Short Form	DIN / IEC Symbol	UL / CSA Symbol
Normally Open	NO, Form A		
Normally Closed	NC, Form B		
Changeover	CO, Form C, SPDT		

**Forced-Guided Contacts:** Electro-mechanical relay contacts that are mechanically linked together, so that when the relay coil is energized or de-energized, all of the linked contacts move together. If one set of contacts in the relay becomes immobilized, no other contact of the same relay will be able to move. An open-contact gap > 0.5 mm ( 0.02 in.) is maintained during life of the relay, even with malfunction, and at 1.6 x Nominal Voltage. Forced-Guided contacts are also known as captive contacts, positive-guided contacts, or locked contacts. They are used in Safety Relays.

# Relay Terminology

## Forced-Guided versus Standard Relay Contacts

### Forced-Guided Relay Contacts

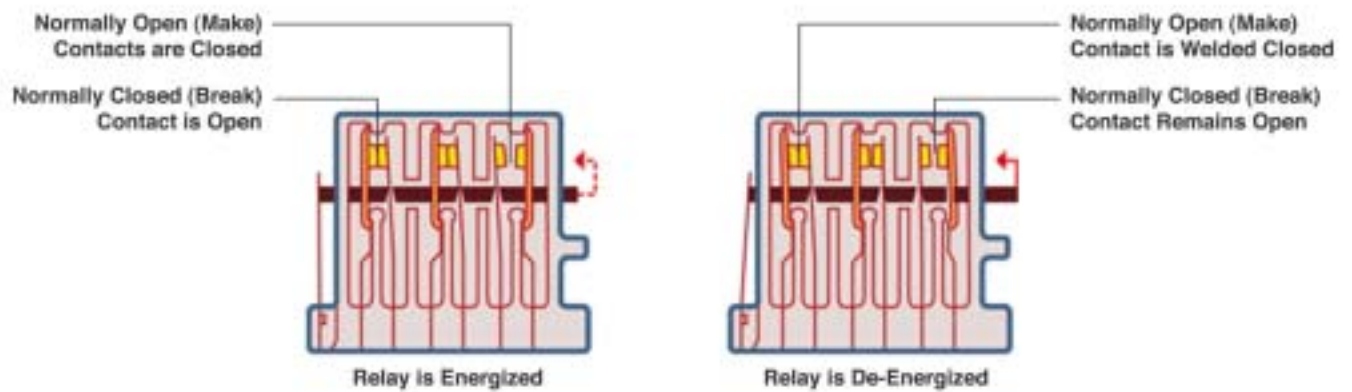

### Standard Relay Contacts

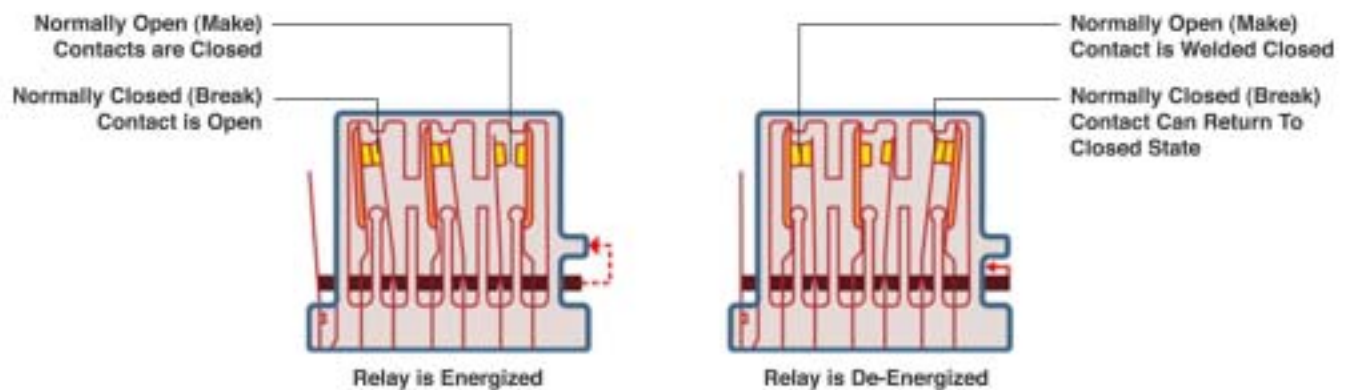

# Relay Terminology

**Flash-Plated:** Thin gold coating of the relay contacts to prevent corrosion during shelf-life (long-time storage).

**Mechanical Life:** Number of expected operation cycles of the relay contacts.

**Mixed Contact Material:** Pertaining to a safety relay on which each single contact can be made of different material, e.g., 6 pole safety relay: 4 n/o contacts made of  $\text{AgCdO} + 0.2\mu\text{mAu}$  and 2 n/c contacts made of  $\text{AgNi} 10 + 5\mu\text{mAu}$ .

**Normally Closed Contact (NC):** A relay contact pair that is closed when the coil is not energized.

**Normally Open Contact (NO):** A relay contact pair that is open when the coil is not energized.

**Nominal Coil Voltage:** The voltage by which the coil is designated and to which certain operating characteristics of the relay are related.

**Operating Voltage:** The voltage by which the relay performs to the desired function.

**Pin Diagram:** A diagram of the points at which a connection is made between the relay and the circuit board.

**Protection Rating:** Classification system for the sealing effectiveness of electrical equipment to protect against foreign bodies. In a two digit code, the first digit indicates the protection against solid objects, while the second indicates protection from moisture.

**International Protection (IP, according to IEC 529):** Protection against a process whereby unwanted material enter the relay to occupy space that would otherwise remain free of such material.

**IP 40, First digit 4:** Protection from entry by solid objects with a diameter greater than 1.0 mm.  
Second digit 0: no special protection against moisture

**IP 67, First digit 6:** Dust-tight.  
Second digit 7: Protection against immersion.

**Relay Operate Time:** The time interval from coil energization to the functioning time of the last contact to function.

**Relay Release Time:** The time interval from coil de-energization to the functioning time of the last contact to function.

**Safety Relay:** An electro-mechanical relay with forced-guided contacts used in Safety Devices such as Emergency Stop Modules, Safety Gate Monitors, 2-Hand Safety Modules, Safety Light Curtains, etc.

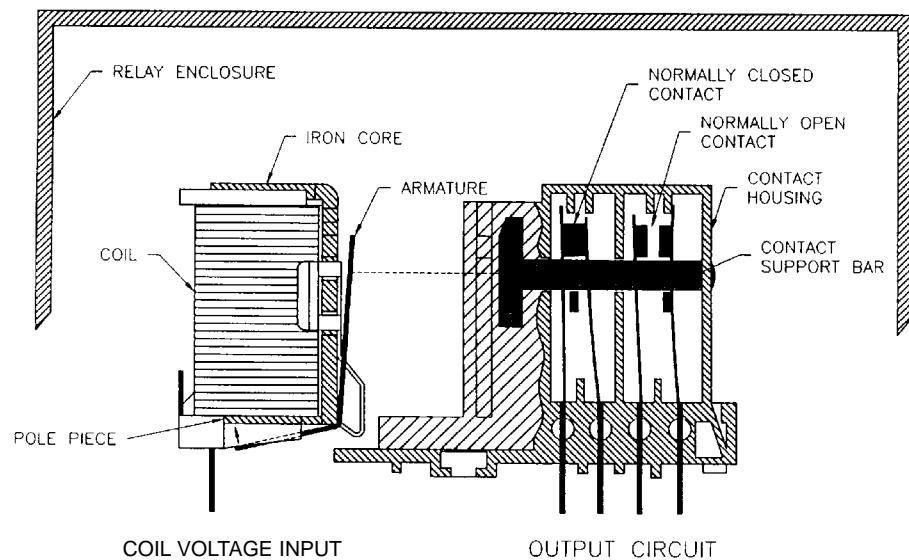

**Switching Current:** The value of the root-mean-square (rms) symmetrical current expressed in amperes, which the relay output contact interrupts at the rated maximum voltage and rated frequency.

**Switching Power:** The value of the product of switching voltage x switching current, which the relay output interrupts under certain test conditions.

**Switching Voltage:** The value of the voltage expressed in volt, which the relay output contact interrupts at the rated maximum current and rated frequency.

**Voltage Range:** The region between the lower and upper limits in regards of the Nominal Coil Voltage.

**Washable:** A sealed construction allows automatic washing and cleaning of the PC board.

# Accessories



Socket for OA/OW 5669\*



Socket for OA 5601\*



Socket for OA 5602\*

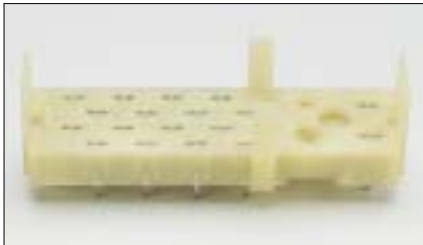

Socket for OA 5603\*



Socket for OA 5611/12\*



Extraction Tool\*\*

\*\*Note: Extraction tool for de-mounting the relay from the socket is only available for OA5601/02/03.

## Ordering Information

Relay Style	Matching Socket Type	Extraction-Tool Type	Hold Down Clip Type
OA/OW 5669	56.5669.00	n.a.	56.5669.99
OA 5667	n.a.	n.a.	n.a.
OA 5601	56.5601.01	56.5601.10	n.a.
OA 5602	56.5602.02	56.5602.20	n.a.
OA 5603	56.5603.03	56.5603.30	n.a.
OA 5611	56.5611.11	n.a.	n.a.
OA 5612	56.5612.12	n.a.	n.a.

\*Current data sheets of sockets are available on request.